

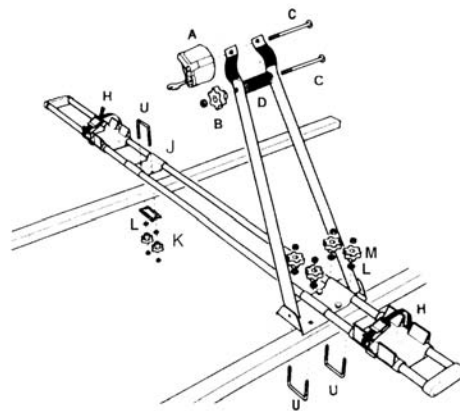

Assembly instructions

Mount the hand wheel **B** to the tubular frame using the screw **G** washer **9** and the spring **D**. (Fig. 1) Mount the cycle rack to the front load-bearing bars: Using the supplied U-bracket **U**, the washers **L** and knurled nuts **M**, mount the cycle rack to the roof rack (Fig. 3). Assembly of the cycle rack on the rear load-bearing bars: Place the cycle rack onto the roof rack and align. Using the assembly plates **J+K**, the U-bracket **I**, washers **L** and knurled nuts **M**, attach the cycle rack. Place the clamp pads of the tubular frame to the front, sloping frame part of the cycle and tighten using the hand wheel **B**. Attach the pivot screw with the toggle nut **5**. Slide the wheel mounts onto each end followed by the end caps **E**. Tighten the wheels in the wheel groove using the holding belt **H** (Fig 2).



Safety information:

Check the screws for the first time after driving a short distance and then at regular intervals. Please note that the load on the roof will change the driving properties of your vehicle during braking, in the case of side winds and when driving round bends. Adjust your driving speed accordingly. In particular, observe the information provided by the manufacturer of the vehicle about the permitted roof loads. Parts of the cycles, such as e.g. handlebars or pedals, should not protrude over the edge of the roof. If not needed, the cycle rack should be dismantled for reasons of safety for other road users and economy (petrol consumption). CAUTION: When the cycle is mounted, note the greater height of your vehicle when entering underground car parks, tunnels etc. Before setting off on your journey, always check that the attachments are all correct. IMPORTANT: Always use the supplied holding belt. Deadweight of the cycle rack: 2.9 kg

Art. No. 12014

SUPER BIKE

FIG. 1



FIG. 2

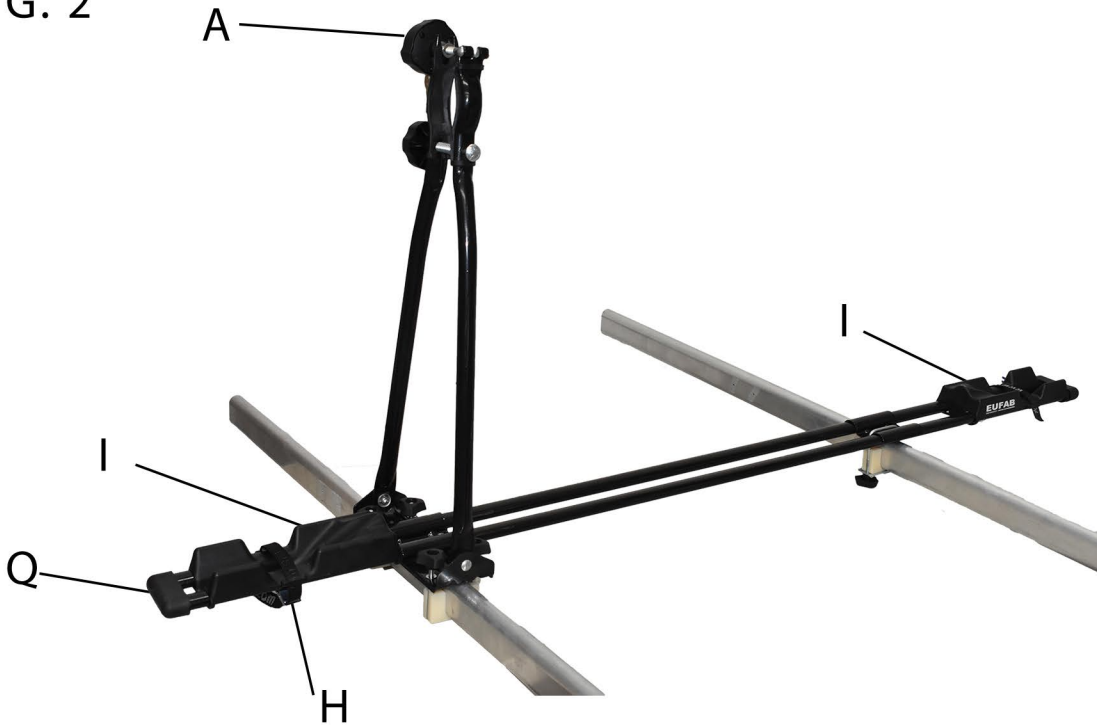
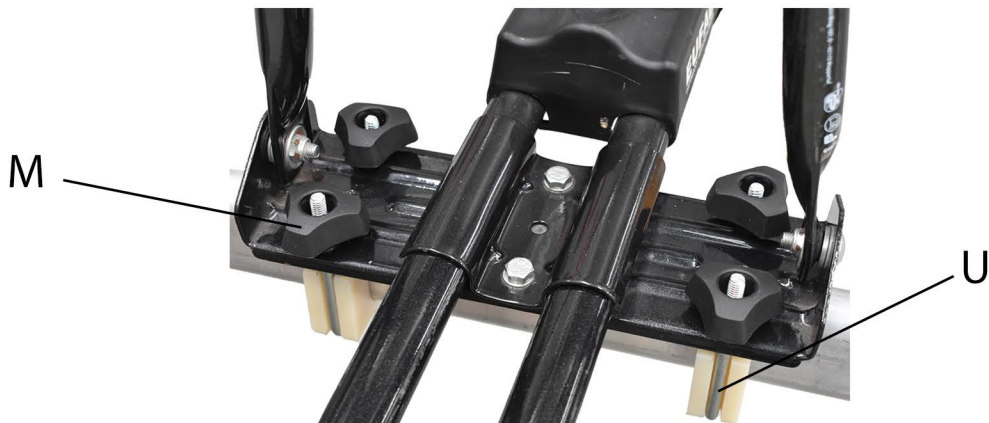















FIG. 3



PART DESCRIPTION	PART INSTALLATION CODE	PART IMAGE	X	N°
End cap	Q		2	90158
U-bracket	U		3	90159
Lower plate	J		1	90160
Upper plate	K		1	90161
Hand Wheel	B		1	90140
Knurled nut M6	M		6	90176
Toggle nut M8;	A		1	90511

ADDITIONAL U-BRACKETS AND T-SLIDE
TO SUIT CAR ROOF RACKS
60W x 55H mm



PART DESCRIPTION	PART INSTALLATION CODE	PART IMAGE	X	N°
Wheel Mount	I		2	90679
Tension belt, small	H		2	90230
washer M8	E		2	90252
washer M6	L		6	90251
Pressure spring	D		1	90685
Lock screw M8 x 120	G		1	90686

Additional Roof rack accessories such as additional cross bar rails and roof rack baskets are available from your nearest caravan accessories outlet. Visit www.coastrv.com.au to learn more and to find your nearest stockist.



EAL GmbH, Otto-Hausmann Ring 107, D-42115 Wuppertal